

 **BREED®**

**USER  
GUIDE**



**X SERIES  
7-PIECE  
DINING SET**

## BEYOND THE FIRE

Your backyard is more than a space—it's an experience. The Breeo X Series® Dining Set is designed to bring people together, creating a seamless transition from fireside gatherings to open-air meals. Built with the same durable poly lumber and stainless steel hardware as our beloved X Series furniture, this dining set is crafted to withstand the elements and elevate your outdoor space. Whether you're grilling over the flames or sharing a meal under the stars, the X Series Dining Set ensures your backyard is ready for every moment.

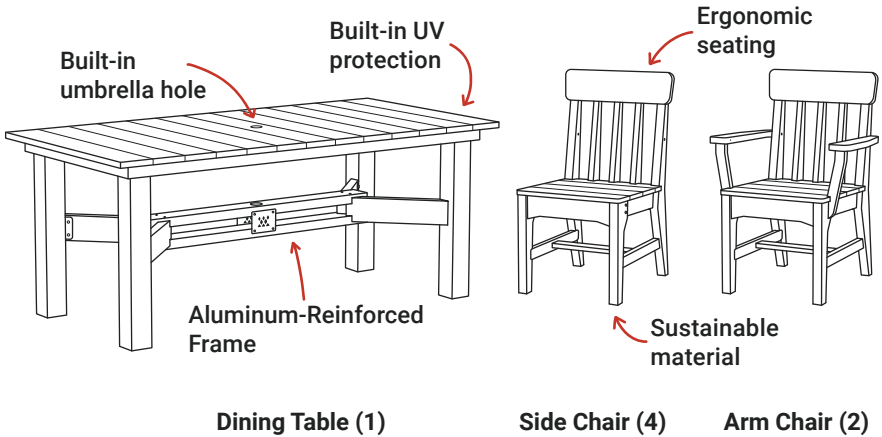

## FEATURES

**HEAVY-DUTY CONSTRUCTION:** Made in the USA and designed with 4x4 table legs, a reinforced center support, and 1.5 in. thick chair legs for unmatched durability.

**PREMIUM POLY LUMBER:** Color-stable, weather-resistant, and maintenance-free—built to last for years with minimal upkeep.

**ALUMINUM-REINFORCED FRAME:** Provides maximum stability for a wobble-free dining experience.

**ERGONOMIC SEATING:** Both arm and side chairs are designed for comfort and durability, featuring easy arm attachment and fully assembled frames (arms require simple installation).

**SEAMLESS X SERIES INTEGRATION:** Designed to visually and functionally complement the Breeo X Series furniture line. Use the X Series Bench as additional seating and create a fully integrated outdoor living space.

# ASSEMBLY INSTRUCTIONS

## PARTS INCLUDED

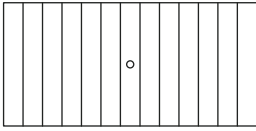

Tabletop x1



Table Legs x4

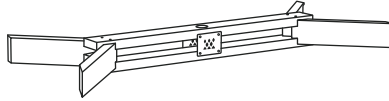
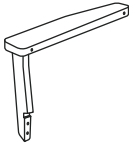

Table Support Bar x1



Chairs x6



Right Arms x2

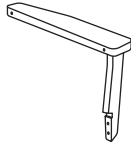

Left Arms x2



Hex Head  
Screws x24



2.5 in. Bolts for  
Arm Chair x12

## TOOLS NEEDED

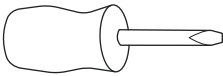

Flat Head Screwdriver or Socket Wrench x1

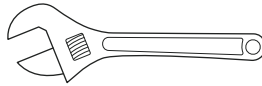

Hex Key x1

## 1 ATTACH THE TABLE LEGS TO THE SUPPORT BAR

Match the lettered labels on each section to their corresponding part.

Install the 4 table legs onto the table support bar using 2 hex head bolts for each corner with a flat head screwdriver or socket wrench.

Make sure both the pilot holes for the tabletop frame and the Breco logo flame are facing up.

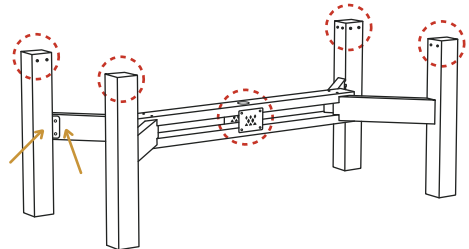
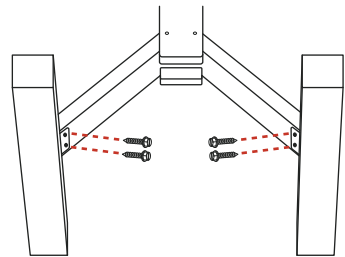

### PLEASE NOTE:

To prevent cross-threading the screws, start every screw by hand till it turns freely and smoothly in the thread. Then use the hex key to tighten down.

## 2 ATTACH THE TABLETOP

With a partner, set the tabletop onto the standing frame and slide each leg into the proper corner slot. Make sure to match the letter on the corner of the table to the legs.

Using 4 hex head screws per leg, secure the frame onto the top of the legs with the screwdriver or socket wrench.

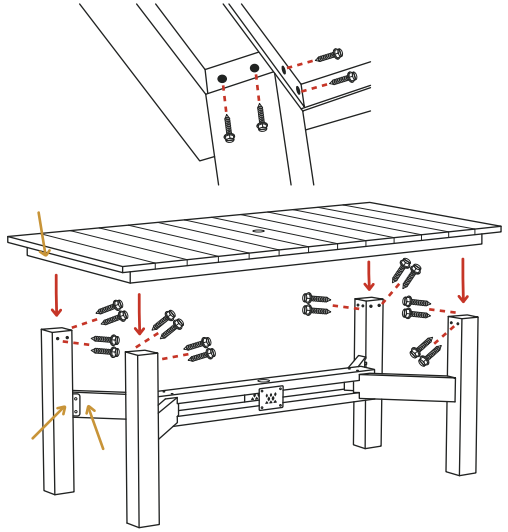

## 3 ATTACH THE DINING ARM CHAIRS

The dining chairs come with no arms installed. You have 2 sets of arms to install.

Line up the back of the left arm to the back post of the chair. Loosely screw in a 2.5 in. bolt and hand tighten. Repeat for the other side. Wait to tighten until all screws are in place.

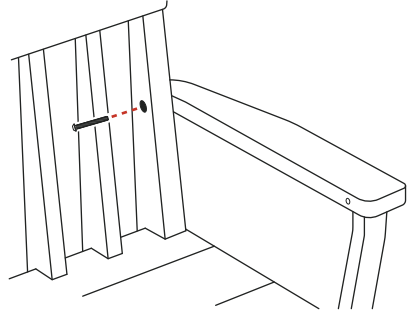

## 4 SECURE THE ARMS TO THE CHAIR

Flip the chair over and line the holes on the side with the holes in the arm. Insert 2 of the 2.5 in. bolts and hand tighten. Repeat for the other side of the arm.

Using the hex key, tighten down all the bolts. Be careful not to over-tighten and strip the insert.

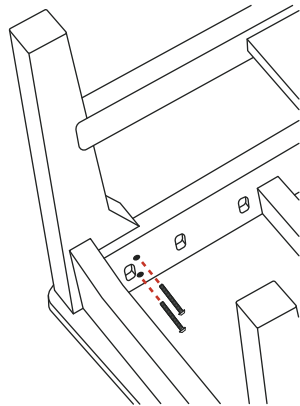

## USE & CARE

We recommend 2 people lift for placement. For a quick clean, add dish soap and warm water to a bucket and wipe any dirt off the surface, rinse with clean water, and let it air dry.

## WARNING

Do not stand on the X Series Dining Table or Chairs for risk of falling or injury. Do not allow any hot surfaces to make contact with any of the poly lumber. Do not use the top of the X Series Dining Table as a cutting board.

Do not exceed any weight of 350 lbs on the X Series Dining Chairs.

**⚠️ WARNING:** This product can expose you to nickel, which is known to the State of California to cause cancer and birth defects or reproductive harm. For more information go to [www.p65warnings.ca.gov](http://www.p65warnings.ca.gov)



# WARRANTY

## Breco X Series® Limited Furniture Warranty

THIS LIMITED WARRANTY GIVES YOU SPECIFIC LEGAL RIGHTS AND YOU MAY ALSO HAVE OTHER RIGHTS, WHICH VARY FROM STATE TO STATE. What does this Limited Warranty cover? Breco, LLC (hereinafter "BRECO") warranties to the original purchaser ("Purchaser") that, for a period of twenty (20) years (except as specified below) of residential use from the date of purchase, under normal use and service conditions, BRECO X Series® furniture (the "product") shall be free from material defects, and shall not splinter, crack, chip, peel, or rot, or suffer structural damage from insect infestation. This warranty does not extend to any subsequent owner or other transferee of the product.

**304 Stainless Steel Frames & Accessories.** Welds and joints are warranted to not break or crack for five (5) years of residential use. Hardware. Hardware used in production or assembly of Breco X Series furniture is warranted to not break for five (5) years of residential use.

**Making a Claim.** To make a claim under this limited warranty, Purchaser shall send to BRECO, within the warranty period referred to above, (1) a description of the BRECO X Series® furniture and claimed defect, (2) proof of purchase (including the serial number for the product), and (3) photographs of the defect to the following address: 5002 Lincoln Hwy E. Attn: Warranty Claims Kinzers, PA 17535. If a product is covered by this limited warranty, BRECO, at its option, will repair or replace the product with a new product free of charge, excluding any applicable shipping and handling charges. If the product being warranted has been discontinued, the replacement product will be of equal or similar value.

**Exclusions from the Limited Warranty.** The following items are specifically excluded from this Limited Warranty: BRECO shall not be liable for any failure, defect or damage resulting from or connected with the following: • Fading, color change or color match. To minimize possible fading: keep product covered, utilize cushions where applicable, minimize direct sunlight by storing product when not in use, or use a UV-protectant • Color or pattern variance between any new replacement section or pieces and other sections or pieces • Rust or corrosion of stainless steel or zinc coated steel hardware (please see Cleaning/Maintenance information for details on how to maintain your hardware) • Damage caused by, among other things, use of incompatible accessories, intentional acts, unreasonable use, misuse, physical abuse, permanent deformation or destruction by human or animal, vandalism, riot, insurrection or civil disorder, accidents or corrosive atmospheres (such as those contaminated by acid rain, harmful chemicals or vapors), or any act of God (such as fire, flooding, hurricane, earthquake, tornado, lightning). We reserve the right to discontinue or modify any product line or color without notifying the Purchaser. If the original product is not available, we retain the right to choose to provide replacement material of equal value or quality. No person or entity is authorized by BRECO to make and BRECO shall not be bound by any statement or representation as to the quality or performance of BRECO products other than as contained in this warranty. This warranty may not be altered or amended except in a written instrument signed by BRECO and Purchaser. Proper maintenance of your product is required to support the benefits of this warranty. This warranty is voided in the event that there are indications of abuse or neglect to the furniture. This warranty does not apply to normal wear and tear effects on BRECO products, which are received by regular use of the products.

This warranty is effective for products purchased on or after 4/1/2022.

THIS WARRANTY IS EXPRESSLY IN LIEU OF ALL OTHER WARRANTIES, EXPRESS OR IMPLIED, INCLUDING THE WARRANTY OF MERCHANTABILITY AND FITNESS FOR A PARTICULAR PURPOSE. NO ORAL AGREEMENT, GUARANTEE, PROMISE, REPRESENTATION OR WARRANTY SHALL BE BINDING. IN NO EVENT WILL BRECO BE LIABLE FOR ANY SPECIAL, INDIRECT, INCIDENTAL OR CONSEQUENTIAL DAMAGES EVEN IF BRECO HAS BEEN ADVISED OF THE POSSIBILITY OF SUCH DAMAGES AND EVEN IF BRECO HAS KNOWLEDGE THAT FAILURE TO PERFORM COULD CAUSE CONSEQUENTIAL ECONOMIC LOSSES. IN ANY EVENT, CUMULATIVE DAMAGES FOR BREACH OF THIS WARRANTY WILL BE LIMITED TO THE AMOUNT ACTUALLY PAID TO BRECO FOR THE PRODUCT. THIS PARAGRAPH SHALL APPLY TO ALL ACTIONS RELATED TO THE PRODUCT, WHETHER BASED ON TORT, CONTRACT OR OTHER THEORIES. THE PURCHASER ACKNOWLEDGES THAT THIS PARAGRAPH ALLOCATES THE RISK OF PRODUCT FAILURE BETWEEN BRECO AND THE PURCHASER, AND THAT THIS ALLOCATION IS REFLECTED IN THE PRICE PAID. Some states do not allow the exclusions or limitations of incidental or consequential damages, so the above limitations or exclusions may not apply to you. This warranty gives you specific legal rights, and you may also have other rights that vary from state to state. This warranty shall only be applicable and enforceable in the United States of America and Canada.

## EARN POINTS & ENJOY MEMBERSHIP BENEFITS

# BECOME A FIREMASTER

- 1 SIGN UP**  
Create an account and earn points.  
[breco.com/pages/rewards](https://breco.com/pages/rewards)
- 2 EARN POINTS**  
Every time you shop.
- 3 REDEEM POINTS**  
For exclusive discounts and products.



**BRECO.COM**

**(800) 413-9848**

**CONTACT@BRECO.COM**

©2025 Breco LLC. All rights reserved. 03/25

**SHARE & TAG  
US ON SOCIAL**



**@BRECO**